

Flow Measurement

SITRANS FM (electromagnetic)

Flow sensors / SITRANS FM MAG 1100 and 1100 HT

Overview



The SITRANS FM MAG 1100 is an electromagnetic flow sensor in a compact wafer design designed for flow applications in the process industry.

Benefits

- Sensor sizes: DN 2 to DN 100 ($1/12$ " to 4")
- Compact wafer design meets EN 1092, DIN and ANSI flange standards
- Corrosion resistant AISI 316 stainless steel sensor housing
- Highly resistant liner and electrodes fitting most extreme process media
- Temperature rating up to 200 °C (392 °F)
- Hose proof IP67/NEMA 6 enclosure rating
- Designed that patented in-situ verification can be conducted. Using SENSORPROM fingerprints

Application

The main applications of the SITRANS FM electromagnetic flow sensors can be found in the following fields:

- Process industry
- Chemical industry
- Pharmaceutical industry
- Water treatment like e.g. chemical dosing

Design

- Compact or remote mounting possible
- Easy "plug & play" field changeability of transmitter
- Simple on-site upgrade to IP68/NEMA 6P terminal box
- ATEX 2G D version
- FM Class I Div 2

Mode of operation

The flow measuring principle is based on Faraday's law of electromagnetic induction according to which the sensor converts the flow into an electrical voltage proportional to the velocity of the flow.

Integration

The complete flowmeter consists of a flow sensor and an associated transmitter SITRANS FM MAG 5000, 6000 or 6000 I. The flexible communication concept USM II simplifies integration and update to a variety of fieldbus systems such as HART, FOUNDATION Fieldbus H1, DeviceNet, PROFIBUS DP and PA, Modbus RTU/RS 485.

Selection and ordering data

Sensor SITRANS FM MAG 1100 EPDM gaskets included		Article No. 7ME6110-	
Click on the Article No. for the online configuration in the PIA Life Cycle Portal.		● ● A ● 0 - ● ● ● ●	
Diameter			
DN 2 (1/12")	1 D		
DN 3 (1/8")	1 H		
DN 6 (1/4")	1 M		
DN 10 (3/8")	1 R		
DN 15 (1/2")	1 V		
DN 25 (1")	2 D		
DN 40 (1 1/2")	2 R		
DN 50 (2")	2 Y		
DN 65 (2 1/2")	3 F		
DN 80 (3")	3 M		
DN 100 (4")	3 T		
Liner material			
PFA - DN 10 ... 100 (3/8" ... 4")		1	
Ceramic		2	
Electrode material			
Hastelloy C (only with PFA liner)			1
Platinum (only with ceramic liner)			2
Transmitter			
Standard sensor for remote transmitter (order transmitter separately)			A
Ex sensor for remote transmitter (order transmitter separately)			B
MAG 6000 I, Aluminum 18 ... 90 V DC, 115 ... 230 V AC, FM / CSA Class I Div. 2			C
MAG 6000 I, Aluminum 18 ... 30 V DC, Ex			D
MAG 6000 I, Aluminum, 18 ... 90 V DC, 115 ... 230 V AC (non-Ex)			F
MAG 6000 I, Aluminum 115 ... 230 V AC, Ex			E
MAG 6000 Polyamide, 11 ... 30 V DC/11 ... 24 V AC			H
MAG 6000, Polyamide, 115 ... 230 V AC			J
MAG 5000, Polyamide, 11 ... 30 V DC/11 ... 24 V AC			K
MAG 5000, Polyamide, 115 ... 230 V AC			L
Communication			
No communication, add-on possible			A
HART			B
PROFIBUS PA Profile 3 (only MAG 6000/MAG 6000 I)			F
PROFIBUS DP Profile 3 (not for Ex) (only MAG 6000/MAG 6000 I)			G
Modbus RTU/RS 485 (not for Ex) (only MAG 6000/MAG 6000 I)			E
FOUNDATION Fieldbus H1 (only MAG 6000/MAG 6000 I)			J
Cable glands/terminal box			
Metric: Polyamide terminal box or MAG 6000 I compact			1
1/2" NPT: Polyamide terminal box or MAG 6000 I compact			2
Metric: Stainless steel terminal box			3
1/2" NPT: Stainless steel terminal box			4

1) Quick ship only in combination with Ceramic liner

Order code	
Additional information	
Please add "-Z" to Article No. and specify Order code(s) and plain text.	
Certificates	
Material certificate according to EN 10204-3.1	C12
Factory certificate according to EN 10204-2.2	C14
Factory certificate according to EN 10204-2.1	C15
Special calibration	
5-point calibration ¹⁾	D01
10-point calibration ²⁾	D06

Flow Measurement

SITRANS FM (electromagnetic)

Flow sensors / SITRANS FM MAG 1100 and 1100 HT

Selection and ordering data (continued)

	Order code
Default (2 × 25 % and 2 × 90 %) matched-pair calibration	D11
5-point, matched-pair calibration ¹⁾	D15
10-point, matched-pair calibration ²⁾	D18
Terminal blocks	
Factory mounted terminal blocks	N02
Country specific label	
CRN (Canadian Registration Number)	H25
Tag name plate	
Tag name plate transmitter, stainless steel (specify in plain text)	Y15
Tag name plate, stainless steel (specify in plain text)	Y17
Tag name plate, plastic (self-adhesive)	Y18
Device settings	
Customer-specific transmitter setting	Y20
Factory mounted sensor cables	
Sensor cables wired	Y40
Sensor cables wired and IP68 sealing	Y41
Additional calibrations	
Accredited matched-pair calibration acc. to ISO/IEC 17025: 2005	On request ³⁾
Customer-specified calibration up to 10 points	On request ³⁾
Customer-witnessed calibration (any of above calibration)	On request ³⁾

¹⁾ 20 %, 40 %, 60 %, 80 %, 100 % of factory Q_{max}

²⁾ Ascending and descending at 20 %, 40 %, 60 %, 80 %, 100 % of factory Q_{max}

³⁾ Product Variation Request (PVR)

Sensor SITRANS FM MAG 1100 HT High Temperature Ceramic liner, Platinum electrode, Graphite gaskets included	Article No. 7ME6120- ● ● A 2 0 - 2 ● A ●									
Click on the Article No. for the online configuration in the PIA Life Cycle Portal.										
Diameter										
DN 15 (½")	1	V								
DN 25 (1")	2	D								
DN 40 (1½")	2	R								
DN 50 (2")	2	Y								
DN 80 (3")	3	M								
DN 100 (4")	3	T								
Transmitter										
Standard sensor for remote transmitter (order transmitter separately)									A	
Ex sensor for remote transmitter (order transmitter separately)									B	
Cable glands/terminal box										
Metric: Stainless steel terminal box										3
½" NPT: Stainless steel terminal box										4

	Order code
Additional information	
Please add "-Z" to Article No. and specify Order code(s) and plain text.	
Certificates	
Material certificate according to EN 10204-3.1	C12
Factory certificate according to EN 10204-2.2	C14
Factory certificate according to EN 10204-2.1	C15
Special calibration	
5-point calibration ¹⁾	D01
10-point calibration ²⁾	D06

Selection and ordering data (continued)

	Order code
Default (2 × 25 % and 2 × 90 %) matched-pair calibration	D11
5-point, matched-pair calibration ¹⁾	D15
10-point, matched-pair calibration ²⁾	D18
Terminal blocks	
Factory mounted terminal blocks	N02
Tag name plate	
Tag name plate, stainless steel (specify in plain text)	Y17
Tag name plate, plastic (self-adhesive)	Y18
Device settings	
Customer-specific transmitter setting	Y20
Factory mounted sensor cables	
Sensor cables wired	Y40
Sensor cables wired and IP68 sealing	Y41
Additional calibrations	
Accredited matched-pair calibration acc. to ISO/IEC 17025: 2005	On request ³⁾
Customer-specified calibration up to 10 points	On request ³⁾
Customer-witnessed calibration (any of above calibration)	On request ³⁾

¹⁾ 20 %, 40 %, 60 %, 80 %, 100 % of factory Q_{max}

²⁾ Ascending and descending at 20 %, 40 %, 60 %, 80 %, 100 % of factory Q_{max}

³⁾ Product Variation Request (PVR)

Description	Article No.
• English	A5E02435647

All literature is available to download for free, in a range of languages, at www.siemens.com/processinstrumentation/documentation

Accessories

Description	Article No.	
Potting kit for IP68/ NEMA 6P sealing of sensor junction box	FDK:085U0220	

Accessories for MAG 1100 sensor

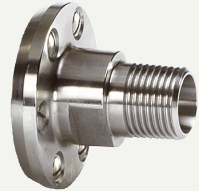



Description	Article No.	
Pipe connection 1/2" external thread For DN 2 ... 10 (1/12" ... 3/8") sensor Material: Stainless steel AISI 316L 2 pcs. pipe connections, 2 pcs. EPDM gaskets, 12 pcs. M4x12 screws	FDK:083G0080	
• R1/2" ISO 7-1 tapered thread	FDK:083G4330	
• 1/2" NPT thread For DN 2 ... 10 (1/12" ... 3/8") sensor Material: Hastelloy C, 2 pcs. pipe connections, 2 pcs. PTFE gaskets, 12 pcs. M4x12 screws		

Flow Measurement





SITRANS FM (electromagnetic)

Flow sensors / SITRANS FM MAG 1100 and 1100 HT

Selection and ordering data (continued)

Description	Article No.	
<ul style="list-style-type: none"> • R$\frac{1}{2}$" ISO 7-1 tapered thread • $\frac{1}{2}$" NPT thread <p>For DN 2 ... 10 (1/12" ... 3/8") sensor Material PVDF (Kynar 1000) 2 pcs. pipe connections (Max. 70 °C, PN 8 bar/max 158 °F, 116 PSI), 1 pc. grounding ring ¹⁾, 1 pc. grounding wire, 3 pcs. PTFE gaskets, 2 pcs. space rings, 6 pcs. M4×12 and 6 pcs. M4×20 screws</p> <ul style="list-style-type: none"> • G$\frac{1}{2}$" ISO 7-1 tapered thread incl. grounding ring • $\frac{1}{2}$" NPT thread incl. grounding ring 	<p>FDK:083G4332</p> <p>FDK:083G4331</p> <p>A5E01018395</p> <p>A5E01018400</p>	
<p>EPDM gaskets Material: EPDM; each set includes: 2 pcs. EPDM gaskets, 1 pc. grounding wire, 1 pc. M6 screw, 1 pc. nut, 1 pc. washer, 1 pc. bolt grounding plate</p> <ul style="list-style-type: none"> • DN 2 ... 10 (1/12" ... 3/8") • DN 15 ($\frac{1}{2}$") • DN 25 (1") • DN 40 (1$\frac{1}{2}$") • DN 50 (2") • DN 65 (2$\frac{1}{2}$") • DN 80 (3") • DN 100 (4") 	<p>FDK:083G3116</p> <p>FDK:083G3117</p> <p>FDK:083G3119</p> <p>FDK:083G3121</p> <p>FDK:083G3122</p> <p>FDK:083G3123</p> <p>FDK:083G3124</p> <p>FDK:083G3125</p>	
<p>PTFE gaskets Material: PTFE; each set includes: 2 pcs. gaskets, 2 pcs. grounding wires, 3 pcs. M6 screws (DN 2 ... 10: 12 pcs. M4×14)</p> <ul style="list-style-type: none"> • DN 2 ... 10 (1/12" ... 3/8") • DN 15 ($\frac{1}{2}$") • DN 25 (1") • DN 40 (1$\frac{1}{2}$") • DN 50 (2") • DN 65 (2$\frac{1}{2}$") • DN 80 (3") • DN 100 (4") 	<p>FDK:083G0156</p> <p>FDK:083G0157</p> <p>FDK:083G0159</p> <p>FDK:083G0161</p> <p>FDK:083G0162</p> <p>FDK:083G0163</p> <p>FDK:083G0164</p> <p>FDK:083G0165</p>	
<p>Graphite gaskets Material: Graphite; conductive, each set includes: 2 pcs. gaskets (can also be used as grounding ring)</p> <ul style="list-style-type: none"> • DN 2 ... 10 (1/12" ... 3/8") • DN 15 ($\frac{1}{2}$") • DN 25 (1") • DN 40 (1$\frac{1}{2}$") • DN 50 (2") • DN 65 (2$\frac{1}{2}$") • DN 80 (3") • DN 100 (4") 	<p>FDK:083G0116</p> <p>FDK:083G0117</p> <p>FDK:083G0119</p> <p>FDK:083G0121</p> <p>FDK:083G0122</p> <p>FDK:083G0123</p> <p>FDK:083G0124</p> <p>FDK:083G0125</p>	
<p>Grounding ring (stainless steel) Material: AISI 316L/1.4404; each set includes: 1 pc. grounding ring¹⁾, 3 pcs. PTFE gaskets, 1 pc. earth wire, 1 pc. M6 screw</p> <ul style="list-style-type: none"> • DN 2 ... 10 (1/12" ... 3/8") • DN 15 ($\frac{1}{2}$") • DN 25 (1") • DN 40 (1$\frac{1}{2}$") • DN 50 (2") • DN 65 (2$\frac{1}{2}$") • DN 80 (3") 	<p>FDK:083G0686</p> <p>FDK:083G0687</p> <p>FDK:083G0689</p> <p>FDK:083G0691</p> <p>FDK:083G0692</p> <p>FDK:083G0693</p> <p>FDK:083G0694</p>	

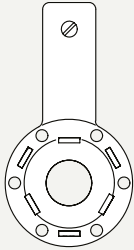
Selection and ordering data (continued)

Description	Article No.	
<ul style="list-style-type: none"> • DN 100 (4") 	FDK:083G0695	
<p>Grounding ring (Hastelloy C) Material: Hastelloy C22/2.4602; each set includes: 1 pc. grounding ring¹⁾, 3 pcs. PTFE gaskets, 1 pc. earth wire, 1 pc. M6 screw</p> <ul style="list-style-type: none"> • DN 2 ... 10 (1/12" ... 3/8") • DN 15 (1/2") • DN 25 (1") • DN 40 (1 1/2") • DN 50 (2") • DN 65 (2 1/2") • DN 80 (3") • DN 100 (4") 	FDK:083G3256 FDK:083G3257 FDK:083G3259 FDK:083G3261 FDK:083G3262 FDK:083G3263 FDK:083G3264 FDK:083G3265	
<p>Grounding ring (Tantalum) Material: Tantalum; each set includes: 1 pc. grounding ring¹⁾, 3 pcs. PTFE gaskets, 1 pc. earth wire, 1 pc. M6 screw</p> <ul style="list-style-type: none"> • DN 2 ... 10 (1/12" ... 3/8") • DN 15 (1/2") • DN 25 (1") • DN 40 (1 1/2") • DN 50 (2") • DN 65 (2 1/2") • DN 80 (3") • DN 100 (4") 	ASE01181599 ASE01181606 ASE01181610 ASE01181613 ASE01181615 ASE01181616 ASE01181619 ASE01181622	 
<p>Studs and nuts For DN 100 PN 25/40, 8 pcs. M20 studs, 16 pcs. M20 nuts Material: AISI 304/1.4305</p> <ul style="list-style-type: none"> • DN 100 (4") 	FDK:083G0226	

¹⁾ Thickness of grounding ring is 2 mm (0.08 inch)

Flow Measurement

SITRANS FM (electromagnetic)

Flow sensors / SITRANS FM MAG 1100 and 1100 HT

Technical specifications

Version	MAG 1100	MAG 1100 HT (High Temperature)
Measuring principle	Electromagnetic induction	Electromagnetic induction
Excitation frequency (mains supply: 50 Hz/60 Hz)	DN 2 ... 65 (1/12" ... 2½"): 12.5 Hz/15 Hz DN 80, 100 (3", 4"): 6.25 Hz/7.5 Hz	DN 15 ... 50 (½" ... 2"): 12.5 Hz/15 Hz DN 80, 100 (3", 4"): 6.25 Hz/7.5 Hz
Process connection		
Nominal size		
• MAG 1100 (Ceramic)	DN 2 ... 100 (1/12" ... 4")	DN 15 ... 100 (½" ... 4")
• MAG 1100 (PFA)	DN 10 ... 100 (3/8" ... 4")	
Mating flanges	EN 1092-1 (DIN 2501), ANSI B 16.5 class 150 and 300 or equivalent Option: DN 2 ... 10 (1/12" ... 3/8"): G½"/1½" NPT pipe connection adapters	EN 1092-1 (DIN 2501), ANSI B 16.5 class 150 and 300 or equivalent
Rated operating conditions		
Ambient conditions		
Ambient temperature		
• Standard sensor	-40 ... +100 °C (-40 ... +212 °F)	-40 ... +100 °C (-40 ... +212 °F)
• Ex sensor	-20 ... +60 °C (-4 ... +140 °F)	-20 ... +60 °C (-4 ... +140 °F)
• Compact with transmitter MAG 5000/6000	-20 ... +60 °C (-4 ... +140 °F)	
• Compact with transmitter MAG 6000 I ¹⁾	-20 ... +60 °C (-4 ... +140 °F)	
• Compact with transmitter MAG 6000 I Ex ¹⁾	-20 ... +60 °C (-4 ... 140 °F)	
Temperature of medium		
• MAG 1100 (Ceramic)	-20 ... +150 °C (-4 ... +302 °F)	-20 ... +200 °C (-4 ... +392 °F)
• MAG 1100 Ex (Ceramic)	-20 ... +150 °C (-4 ... +302 °F)	-20 ... +180 °C (-4 ... +356 °F)
• MAG 1100 (PFA)	-30 ... +130 °C (-22 ... +266 °F) Suitable for steam sterilization at 150 °C (302 °F)	
Temperature shock		
• MAG 1100 (Ceramic)		
• Duration ≤ 1 min, followed by 10 min rest	• DN 2, 3 (1/12", 1/8") No limitations • DN 6, 10, 15, 25: Max. ΔT ≤ 80 °C/min (½", 3/8", ½", 1": Max. ΔT ≤ 144 °F/min) • DN 40, 50, 65: Max. ΔT ≤ 70 °C/min (1½", 2", 2½"): Max. ΔT ≤ 126 °F/min) • DN 80, 100: Max. ΔT ≤ 60 °C/min (3", 4"): Max. ΔT ≤ 108 °F/min)	• DN 15, 25: Max. ΔT ≤ 80 °C/min (½", 1": Max. ΔT ≤ 144 °F/min) • DN 40, 50: Max. ΔT ≤ 70 °C/min (1½", 2": Max. ΔT ≤ 126 °F/min) • DN 80, 100: Max. ΔT ≤ 60 °C/min (3", 4": Max. ΔT ≤ 108 °F/min)
• MAG 1100 (PFA)	Max. ± 100 °C (212 °F) momentarily	
Operating pressure		
• MAG 1100 (Ceramic)	• DN 2 ... 65: 40 bar (1/12" ... 2½": 580 psi) • DN 80: 37.5 bar (3": 540 psi) • DN 100: 30 bar (4": 435 psi) Vacuum: 1 x 10 ⁻⁶ bar _{abs} (1.5 - x 10 ⁻⁵ psi _{abs})	• DN 15 ... 50: 40 bar (½" ... 2": 580 psi) • DN 80: 37.5 bar (3": 540 psi) • DN 100: 30 bar (4": 435 psi) Vacuum: 1 x 10 ⁻⁶ bar _{abs} (1.5 - x 10 ⁻⁵ psi _{abs})

Technical specifications (continued)

Version	MAG 1100	MAG 1100 HT (High Temperature)
• MAG 1100 (PFA)	20 bar (290 psi) Vacuum: 0.02 bar _{abs} (0.3 psi _{abs}) DN 80 ... 100: CO ₂ pressure max. 7 bar (101.5 psi)	
Mechanical load (vibration)	• 18 ... 1000 Hz random in x, y, z, directions for 2 hours according to EN 60068-2-36 • Sensor: 3.17 g RMS • Sensor with compact MAG 5000/6000 mounted transmitter: 3.17 g RMS • Sensor with compact MAG 6000 I/6000 I Ex mounted transmitter: 1.14 g RMS • For compact installation with the MAG 6000 I, transmitter to be supported to avoid tension on sensor part.	• 18 ... 1000 Hz random in x, y, z, directions for 2 hours according to EN 60068-2-36 • Sensor: 3.17 g RMS
Enclosure rating (standard)	IP67 to EN 60529 (NEMA 6), 1 mH ₂ O for 30 min	IP67 to EN 60529 (NEMA 6), 1 mH ₂ O for 30 min
EMC	2014/30/EU	2014/30/EU
Design		
Weight	See Dimensional drawings	See Dimensional drawings
Material		
• Enclosure		
- MAG 1100	Stainless steel AISI 316L/1.4404	Stainless steel AISI 316L/1.4404
• Terminal box		
- Standard	Fibre glass reinforced polyamide (not for Ex)	Stainless steel AISI 316/1.4436
- Option	Stainless steel AISI 316/1.4436	
• Fixing studs	Stainless steel AISI 304/1.4301, Number and size to EN 1092-1:2001	Stainless steel AISI 304/1.4301, Number and size to EN 1092-1:2001
• Gaskets		
- Standard	EPDM (max. 150 °C, PN 40 (max. 302 °F, 600 psi))	Graphite (max. 200 °C, PN 40 (max. 392 °F, 600 psi))
- Option	• Graphite (max. 200 °C, PN 40 (max. 392 °F, 600 psi)) • PTFE (max. 130 °C, PN 25 (max. 266 °F, 300 psi))	
• Pipe connection adapters: DN 2, 3, 6 and 10 (1/12", 1/8", ¼" and 3/8")	• Stainless steel, AISI 316 /1.4436 • Hastelloy C22/2.4602 • PVDF	
Liner		
• MAG 1100 (Ceramic)	• DN 2, 3 (1/12", 1/8"): Zirconium oxide (ZrO ₂) (ceramic) • DN 6 ... 100 (¼" ... 4"): Aluminum oxide Al ₂ O ₃	DN 15 ... 100 (½", 4"): Aluminum oxide Al ₂ O ₃
• MAG 1100 (PFA)	Reinforced PFA (not for Ex)	
Electrodes		
• MAG 1100 (Ceramic)	• DN 10 ... 100 (3/8" ... 4"): Platinum with gold/Titanium brazing alloy • DN 2 ... 6 (1/12" ... ¼"): Platinum	Platinum with gold/Titanium brazing alloy

Technical specifications (continued)

Version	MAG 1100	MAG 1100 HT (High Temperature)
• MAG 1100 (PFA)	<ul style="list-style-type: none"> • DN 10 ... 15 (3/8" ... 1/2"): Hastelloy C276/2.4819 • DN 25 ... 100 (1" ... 4"): Hastelloy C22/2.4602 	
Cable entries	<ul style="list-style-type: none"> • Remote installation: 2 x M20 or 2 x 1/2" NPT • Compact installation: <ul style="list-style-type: none"> - MAG 5000/MAG 6000: 4 x M20 or 4 x 1/2" NPT - MAG 6000 I: 2 x M25 (for supply/output) - MAG 6000 I Ex: 2 x M25 (for supply/output) 	Remote installation 2 x M20 or 2 x 1/2" NPT
Certificates and approvals		
Calibration		
• Default calibration	Zero-point, 2 x 25 %, 2 x 90 %	Zero-point, 2 x 25 %, 2 x 90 %
• Special calibration	5-point calibration: 20 %, 40 %, 60 %, 80 %, 100 % of factory Q _{max} 10-point calibration: ascending and descending at 20 %, 40 %, 60 %, 80 %, 100 % of factory Q _{max} Matched-pair calibration: default, 5-point or 10-point	
Hazardous areas		
• MAG 1100 F (Ceramic)		
- Ex-sensor in compact or remote version with MAG 6000 I Ex	<ul style="list-style-type: none"> • ATEX, EAC Ex - Zone 1 Ex d e ia IIB T6 Gb • ATEX - Zone 21 Ex tD A21 IP67 	<ul style="list-style-type: none"> • ATEX, EAC Ex - Zone 1 Ex d e ia IIB T6 Gb • ATEX - Zone 21 Ex tD A21 IP67
- Standard sensor in compact or remote version with MAG 5000/6000/6000 I	<ul style="list-style-type: none"> • FM - NI Class I Div. 2 Groups A, B, C, D 	<ul style="list-style-type: none"> • FM - NI Class I Div. 2 Groups A, B, C, D
• MAG 1100 F (PFA)		
- Standard sensor in compact or remote version with MAG 5000/6000/6000 I	<ul style="list-style-type: none"> • FM - NI Class I Div. 2 Groups A, B, C, D 	
Pressure equipment	<ul style="list-style-type: none"> • PED – 2014/68/EU • CRN (only PFA) 	• PED – 2014/68/EU
Others	• EAC (Kazakhstan)	• EAC (Kazakhstan)

1) With HART communication max. ambient temperature 50 °C (122 °F).

For technical specification for transmitter - please see section about transmitters.

Flow Measurement

SITRANS FM (electromagnetic)

Flow sensors / SITRANS FM MAG 1100 and 1100 HT

Dimensional drawings

Sensor MAG 1100, compact/remote

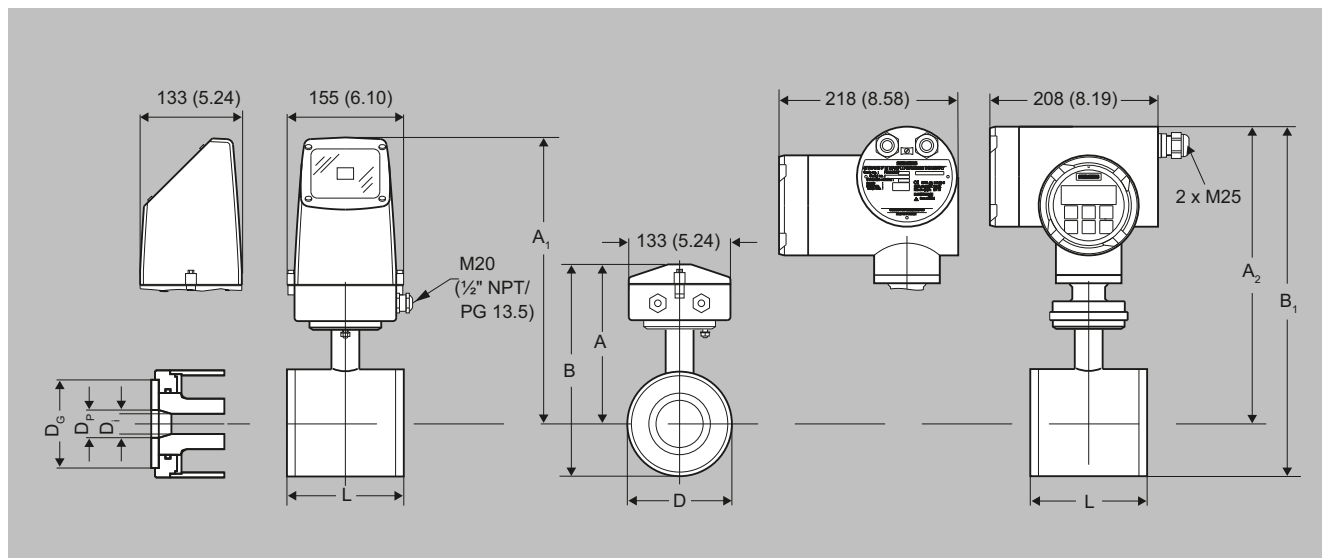

Dimensions in mm (inch)

Important note: For compact installation with MAG 6000 I/Ex - transmitter to be supported to avoid tension on the sensor part

Size DN	A ¹⁾ [mm]	B ¹⁾ [mm]	A ₁ /A ₂ ³⁾ [mm]	B ₁ [mm]	D [mm]	D _i [mm]	D _i (PFA) [mm]	D _p [mm]	D _G [mm]	Weight ²⁾ [kg]
2	161	186	315	340	48.7	2		17.3	34	2.2
3	161	186	315	340	48.7	3		17.3	34	2.2
6	161	186	315	340	48.7	6		17.3	34	2.2
10	161	186	315	340	48.7	10	10	13.6	34	2.2
15	161	186	315	340	48.7	15	16	17.3	40	2.2
25	169	201	323	354	63.5	25	26	28.5	56	2.7
40	179	221	333	375	84.0	40	38	43.4	75	3.4
50	188	239	342	393	101.6	50	50	54.5	90	4.2
65	198	258	351	412	120.9	65	66	68.0	112	5.5
80	204	270	357	424	133.0	80	81	82.5	124	7.0
100	217	296	370	450	159.0	100	100	107.1	150	10.0

Size [inch]	A ¹⁾ [inch]	B ¹⁾ [inch]	A ₁ /A ₂ ³⁾ [inch]	B ₁ [inch]	D [inch]	D _i [inch]	D _i (PFA) [inch]	D _p [inch]	D _G [inch]	Weight ²⁾ [lbs]
1/12	6.34	7.33	12.40	13.39	1.92	0.08		0.68	1.34	4.8
1/8	6.34	7.33	12.40	13.39	1.92	0.12		0.68	1.34	4.8
1/4	6.34	7.33	12.40	13.39	1.92	0.24		0.68	1.34	4.8
3/8	6.34	7.33	12.40	13.39	1.92	0.39	0.39	0.53	1.34	4.8
1/2	6.34	7.33	12.40	13.39	1.92	0.59	0.63	0.68	1.57	4.8
1	6.66	7.92	12.72	13.94	2.50	0.98	1.02	1.12	2.20	5.9
1 1/2	7.05	8.70	13.11	14.76	3.31	1.57	1.50	1.71	2.95	7.5
2	7.40	9.41	13.47	15.47	4.00	1.97	1.97	2.15	3.54	9.2
2 1/2	7.80	10.16	13.82	16.22	4.76	2.56	2.60	2.68	4.41	12
3	8.03	10.63	14.06	16.70	5.24	3.15	3.19	3.25	4.88	15
4	8.54	11.65	14.57	17.72	6.26	3.94	3.94	4.22	5.91	22

¹⁾ 14.5 mm (0.571") shorter when the stainless steel terminal box is used (Ex or high temperature 200 °C (392 °F) version).

²⁾ With transmitter MAG 5000 or MAG 6000 installed, weight is increased by approximately 0.8 kg (1.8 lb). With MAG 6000 I weight is increased with 5.5 kg (12.1 lbs).

³⁾ A₂ is 3 mm (0.12") shorter than A₁

The total built-in length "L" [mm]/[inch] before assembling depends on the gasket selected.

Dimensional drawings (continued)

Size	EPDM		Graphite		PTFE (Teflon)		Without gasket		Grounding ring		
	Inch	[mm]	[inch]	[mm]	[inch]	[mm]	[inch]	[mm]	[inch]	[mm]	[inch]
2 ... 10 ¹⁾	$\frac{1}{12}$... $\frac{3}{8}$	64	2.52	66	2.60	70	2.75	64	2.52	77	3.03
15	$\frac{1}{2}$	65	2.56	66	2.60	70	2.75	64	2.52	77	3.03
25	1	80	3.15	81	3.19	85	3.35	79	3.10	92	3.62
40	$1\frac{1}{2}$	95	3.74	96	3.78	100	3.94	94	3.70	107	4.21
50	2	105	4.13	106	4.17	110	4.33	104	4.05	117	4.61
65	$2\frac{1}{2}$	130	5.12	131	5.15	135	5.31	129	5.05	142	5.60
80	3	155	6.10	156	6.14	160	6.30	154	6.00	167	6.57
100	4	185	7.28	186	7.31	190	7.48	184	7.20	197	7.76

¹⁾ Mounting between two flanges

Sensor MAG 1100 DN 2 ... 10 ($\frac{1}{12}$ " ... $\frac{3}{8}$ ") with adapters

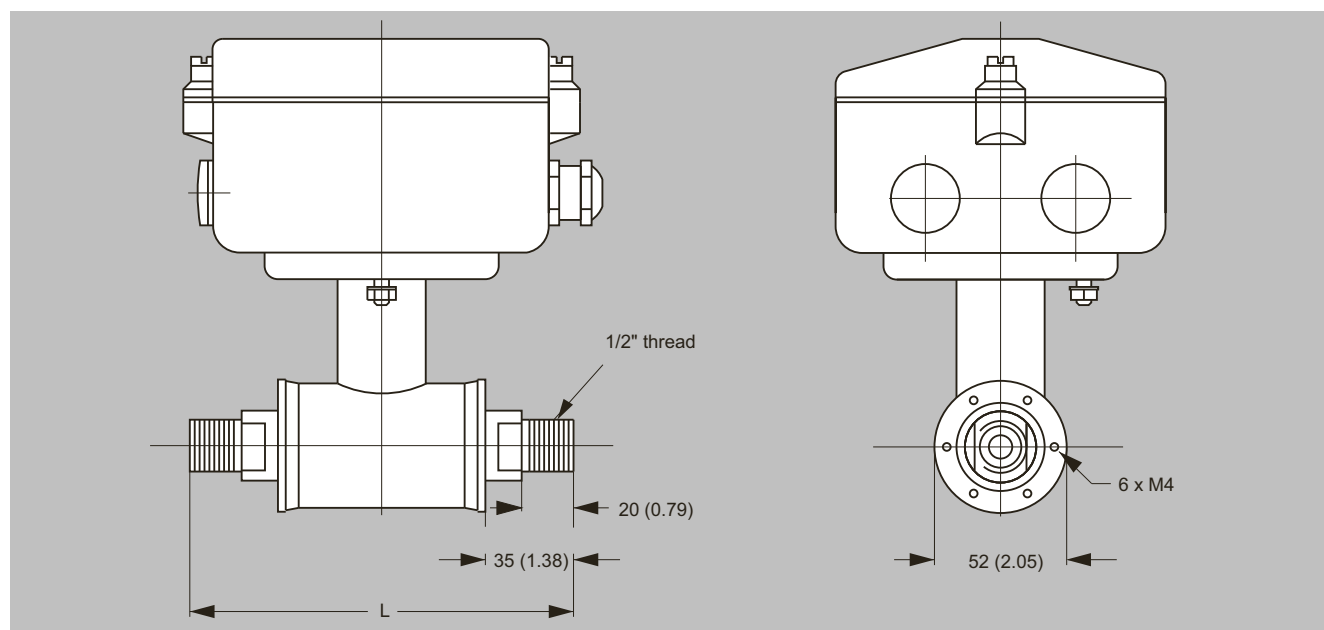

The MAG 1100 DN 2, 3, 6 and 10 ($\frac{1}{12}$ ", $\frac{1}{8}$ ", $\frac{1}{4}$ " and $\frac{3}{8}$ ") are prepared for assembly with the $\frac{1}{2}$ " pipe connections. Dimensions in mm (inch)

The length "L" varies dependent on the gasket choice.

Stainless steel and Hastelloy pipe connections								PVDF pipe connections	
Without gasket		EPDM		Graphite		PTFE		PTFE	
[mm]	[inch]	[mm]	[inch]	[mm]	[inch]	[mm]	[inch]	[mm]	[inch]
150	5.9	150	5.9	152	6.0	156	6.1	133	5.2

Important note:

For compact installation with the MAG 6000 I, transmitter to be supported to avoid tension on sensor part.