

Limit Switches **BM series**

Summary

APPROVALS: UL 508 / CSA C22-2 N. 14 / IEC 60947-5-1



CB-SCHEME certification according to IEC 60947-5-1

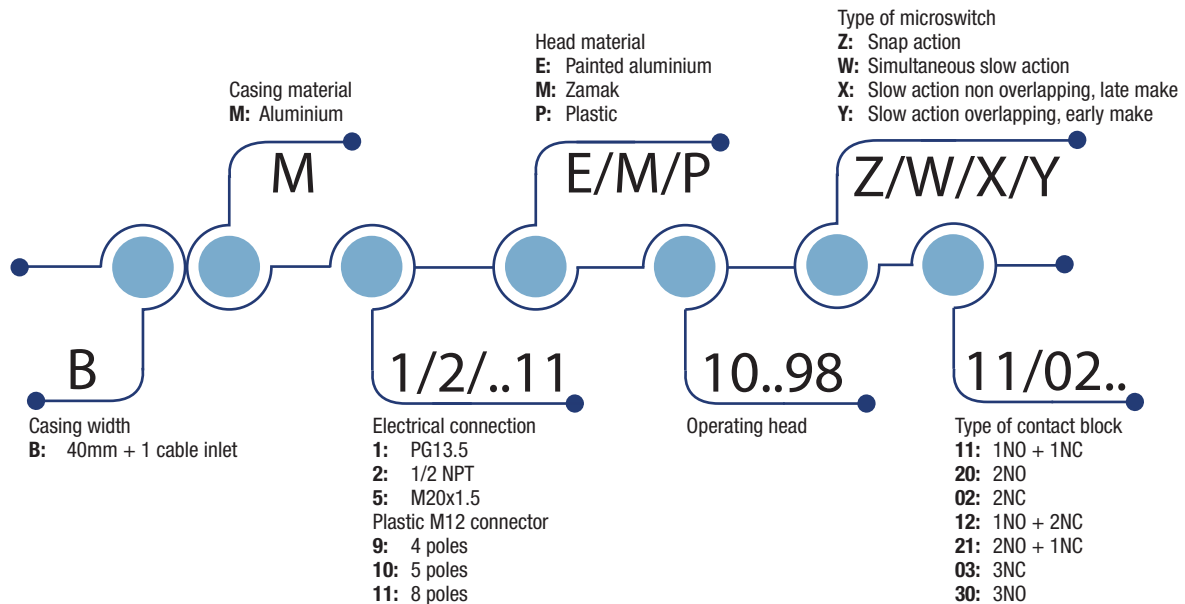

HOW IS IT MADE?

01 A variety of actuators

- Plain plunger
- Roller plunger
- Roller lever, adjustable or not, etc.

02 Wide range of heads

- Assembled using 4 x Ø4 screws

03 Casing:

- 40 mm. with dimensions acc. to EN 50041

04 Mounting screws

- 2 or 4 x M5 screws on top part

05 Cover

- 2 screws 3 pozidriv 1

06 Contact Block

- Positive opening operation
- Snap action or slow action
- Electrically separated contacts

07 Connecting terminals

- Block of 2 contacts: M3.5 (+, -) pozidriv 2 screw
- Block of 3 contacts: M3 (+, -) screw
- Screw head with captive cable clamp
- Markings conform with IEC 60947-1, IEC 60947-5-1 standards

08 Electrical connection

- 1 x threaded cable inlet suitable for cable gland or M12 connector

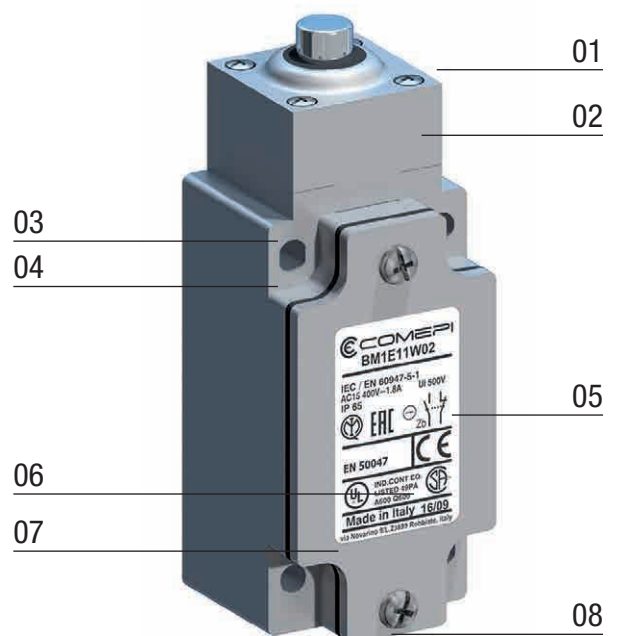

Limit Switches **BM series**

Description

APPLICATIONS

Easy to use, electromechanical limit switches offer specific qualities:

- Visible operation.
- Able to switch strong currents (10 A conventional thermal current).
- Electrically separated contacts.
- Precise operating points (consistency).
- Immune to electromagnetic disturbances.

They are purpose-built detection devices thanks to these characteristics:

- Presence/absence.
- Positioning and travel limit.
- Objects passing/counting.

DESCRIPTION

Limit switches, which are made aluminium, are mechanically more resistant and three times lighter than the ones in zinc alloy and they offer a degree of protection of IP66.

They comply with the requirements of European Directives (Low Voltage and RoHS) and are conform to European and International Standards.

The CE declaration of these products are available in the download section of website www.comepi.it or by writing to the following email address: tecnico@comepi.it
DDC02 - Limit Switches.

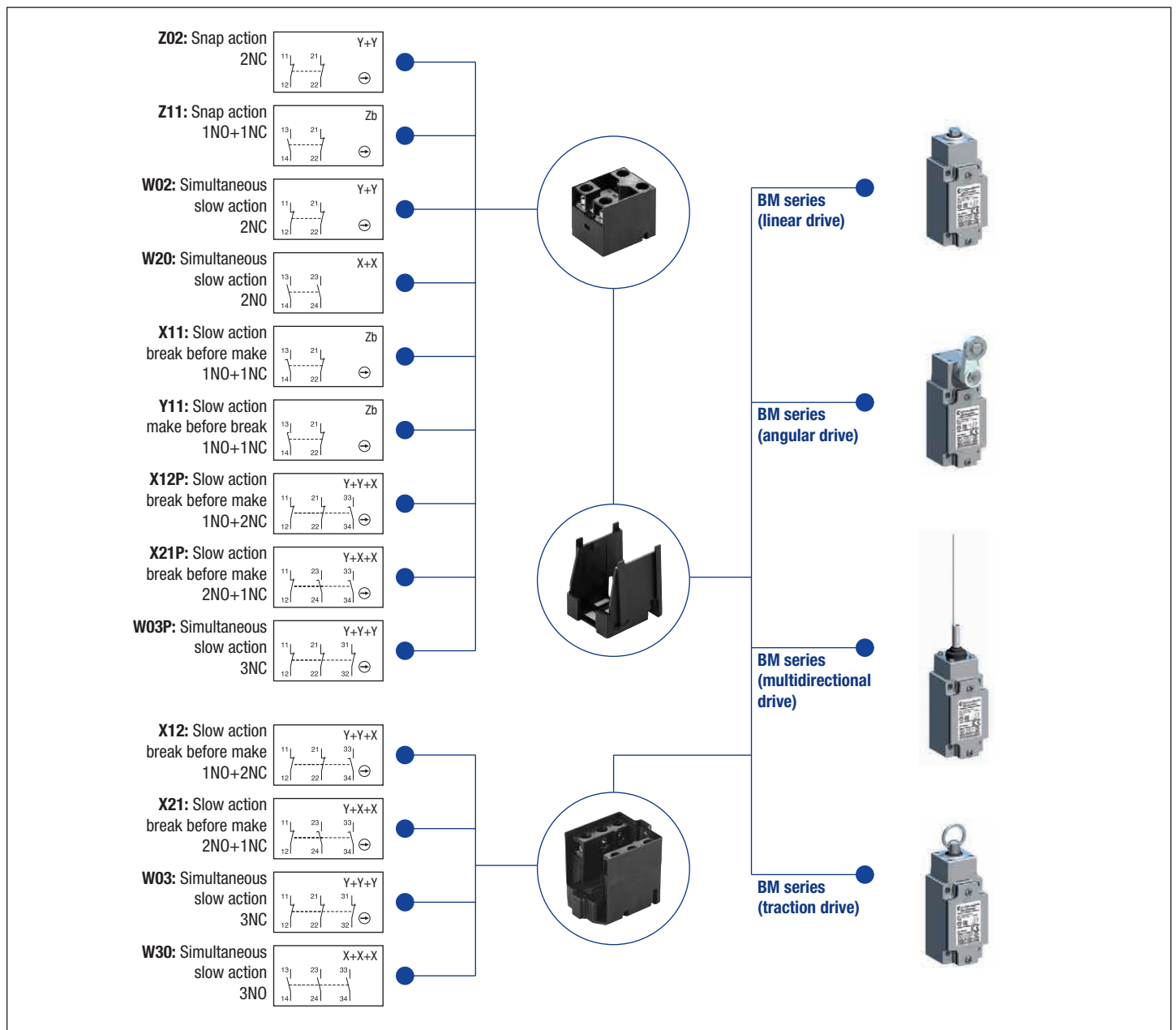

Limit Switches **BM series**

Technical Data

| | BM Series | |
|---|-----------------------------------|---------------|
| Standards | IEC 60947-5-1 EN 60947-5-1 | |
| Certifications - Approvals | UL - CSA - IMQ - EAC - CCC - UKCA | |
| Air temperature near the device | | |
| – during operation | °C | – 25 ... + 70 |
| – for storage | °C | – 30 ... + 80 |
| Mounting positions | All positions are authorised | |
| Protection against electrical shocks (acc. to IEC 61140) | Class I | |
| Degree of protection (according to IEC 60529 and EN 60529) | IP 66* | |

Electrical Data

| | | |
|--|---|---|
| Rated insulation voltage U_i - according to IEC 60947-1 and EN 60947-1 - according to UL 508 and CSA C22-2 n° 14 | 500 V (degree of pollution 3) (400 V for contacts type Z02) A 600, Q 600 | |
| Rated impulse withstand voltage U_{imp} (according to IEC 60947-1 and EN 60947-1) | kV | 6 |
| Conventional free air thermal current I_{th} (according to IEC 60947-5-1) $\theta < 40$ °C | A | 10 |
| Short-circuit protection $U_e < 500$ V a.c. - gG (gl) type fuses | A | 10 |
| Rated operational current I_e / AC-15 (according to IEC 60947-5-1) | 24 V - 50/60 Hz A 120 V - 50/60 Hz A 400 V - 50/60 Hz A | 10 6 4 (1.8A for contacts type X12, X21, W03, W30) |
| I_e / DC-13 (according to IEC 60947-5-1) | 24 V - d.c. A 125 V - d.c. A 250 V - d.c. A | 6 (2.8A for contacts type X12, X21, W03, W30) 0.55 0.4 (0.27A for contacts type X12, X21, W03, W30) |
| Switching frequency | Cycles/h | 3600 |
| Load factor | | 0.5 |
| Resistance between contacts | m Ω | 25 |
| Connecting terminals | M3.5 (+, -) pozidriv 2 screw with cable clamp (M3 for 3 poles contacts type) | |
| Terminal for protective conductor | M3.5 (+, -) pozidriv 2 screw with cable clamp | |
| Connecting capacity | 1 or 2 x mm ² | 0.34 ... 2.5 (0.34... 1.5 for 3 poles contacts type) |
| Terminal marking | According to IEC 60947-5-1 | |
| Recommended tightening torque | Metal | |
| Cover | 0,8Nm, max 0,9 | |
| Head | 0,8Nm, max 0,9 | |
| Microswitch | 0,8Nm, max 0,9 | |
| Mechanical durability | 30 millions of operations 25 millions of operations 10 millions of operations | P11; M13; E11...13; E21...23; E31...33 M41...75; E41...75 P91...93; M14; M19; E91...93; E99 |
| Electrical durability (according to IEC 60947-5-1) | Utilization categories AC-15 and DC-13 (Load factor of 0.5 according to curves below) | |

* except for E54, E92, E93, P92, P93, M54: the degree of protection is IP65

AC-15 - Snap action

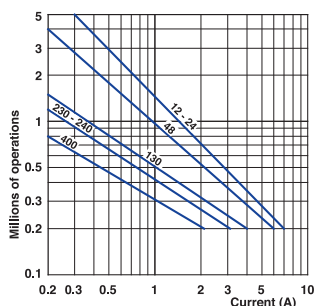

AC-15 - Slow action

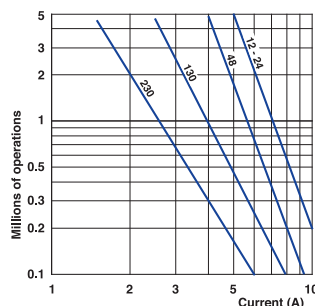

| DC-13 | Snap action | Slow action |
|---------------|---|-------------|
| | Power breaking for a durability of 5 million operating cycles | |
| Voltage 24 V | 9.5 W | 12 W |
| Voltage 48 V | 6.8 W | 9 W |
| Voltage 110 V | 3.6 W | 6 W |

Limit Switches **BM series**

Technical Data

Technical data approved by IMQ

| | | |
|--|--|--|
| Standards | Devices conform with international IEC 60947-5-1 and European EN 60947-5-1 standards | |
| Degree of protection | IP 66* | |
| Rated insulation voltage U_i | 500 V (degree of pollution 3) (400V for type Z02) | |
| Rated impulse withstand voltage U_{imp} | 6 kV | |
| Conventional free air thermal current I_{th} | 10 A | |
| Short-circuit protection - gG (gI) type fuses | 10 A | |
| Rated operational current | | |
| I_e / AC-15 | 24 V - 50/60 Hz | 10 A |
| | 400 V - 50/60 Hz | 4 A (1.8A for contacts type X12, X21, W03, W30) |
| I_e / DC-13 | 24 V - d.c. | 6 A (2.8A for contacts type X12, X21, W03, W30) |
| | 125 V - d.c. | 0.55 A |
| | 250 V - d.c. | 0.4 A (0.27A for contacts type X12, X21, W03, W30) |

* except for E54, E92, E93, P92, P93, M54: the degree of protection is IP65

Technical data approved by UL

| | |
|---|-----------------------------|
| Standards | Devices conform with UL 508 |
| Contact blocks type Z11, X11, Y11, W02 and Z02 | |
| Utilization categories | A600, Q600 |
| Contact blocks type X12, X21, W03 and W30 | |
| Utilization categories | A600, Q600 |

Use 60/75°C copper (Cu) conductor only. Wire rages 14-18 AWG stranded or solid. The terminal tightening torque of 7 lbs-in / 0.78 Nm. Suitable for conduit connection only with use of adapter sleeve optionally provided or recommended by the manufacturer.

For the complete list of approved products, contact our technical department

IMPLEMENTATION

Operating head orientation

The head can be rotated each 90°. Recommended tightening torque 0,5 Nm (max 0,8 Nm).

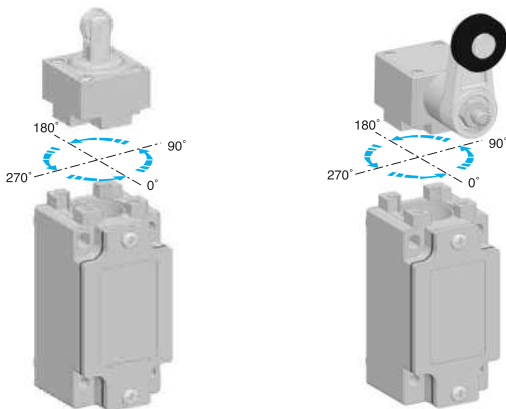

Lever adjustment

The lever of the angular actuators can be adjusted every 9° and round turned in order to obtain the maximum flexibility on the working plan. Recommended tightening torque 0,5 Nm (max 0,8 Nm).

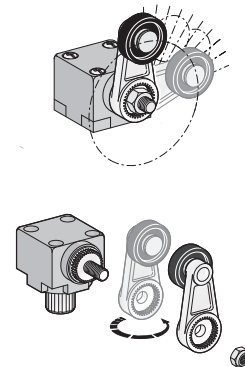

Operating mode selection (BM_E Series only)

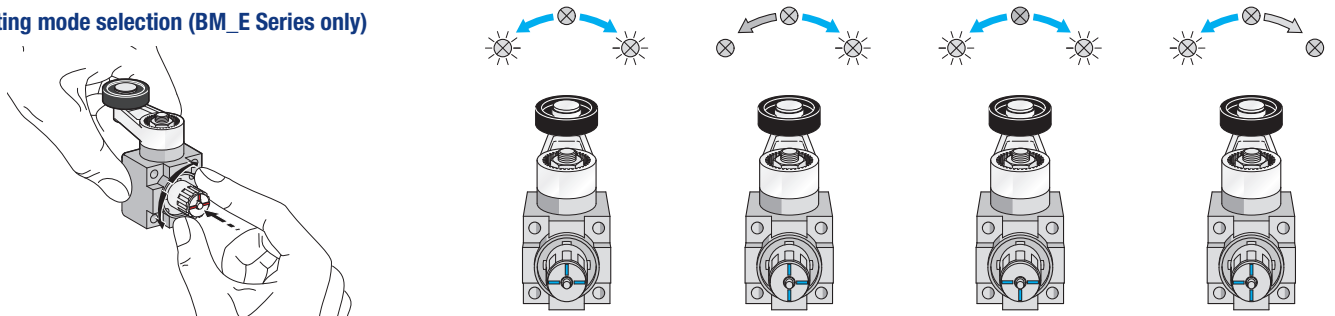

Special Versions



M12 CONNECTOR

Prewired versions with 5 or 8 poles M12 male connectors. Available with plastic threaded body. See page 117 for more details.

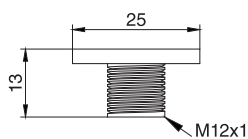

Low Temperature

The limit switches for low temperature applications are useful for refrigerated cells or equipments where the air operational temperature is very low.

These devices, made in special materials, are able to extend the operational temperature range down to -40°C, maintaining mechanical performances intact. To order add the digits "40" following the operating head indication in part number.

For example: BM1E11Z11 ▶ BM1E1140Z11

Limit Switches **BM_E** series

Metal Casing IP66 - 40 mm. width

Electrical connection:

- BM1:** one cable inlet for PG 13,5 Cable Gland
- BM2:** one cable inlet for 1/2" NPT Cable Gland
- BM5:** one cable inlet for M20 x 1,5 Cable Gland
- BM10:** 5 poles M12 plastic connector
- BM11:** 8 poles M12 plastic connector

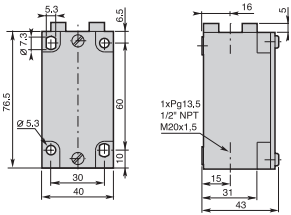

Contact Blocks

| | | | |
|------------------------|-----------|-----------|-----------|
| Z11 (1NO + 1NC) | BM•E11Z11 | BM•E12Z11 | BM•E13Z11 |
| X11 (1NO + 1NC) | BM•E11X11 | BM•E12X11 | BM•E13X11 |
| Y11 (1NO + 1NC) | BM•E11Y11 | BM•E12Y11 | BM•E13Y11 |
| W02 (2NC) | BM•E11W02 | BM•E12W02 | BM•E13W02 |
| W20 (2NO) | BM•E11W20 | BM•E12W20 | BM•E13W20 |
| Z02 (2NC) | BM•E11Z02 | BM•E12Z02 | BM•E13Z02 |
| X12 (1NO + 2NC) | BM•E11X12 | BM•E12X12 | BM•E13X12 |
| X21 (2NO + 1NC) | BM•E11X21 | BM•E12X21 | BM•E13X21 |
| W03 (3NC) | BM•E11W03 | BM•E12W03 | BM•E13W03 |
| W30 (3NO) | BM•E11W30 | BM•E12W30 | BM•E13W30 |

E11 - Stainless steel plain plunger

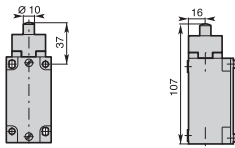

Conformity EN50041
Min. actuating force
Weight

30N (45N \ominus)
240 g

E12 - Stainless steel ball plunger

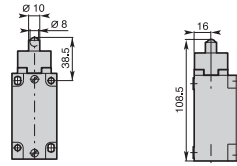

Conformity EN50041
Min. actuating force
Weight

30N (45N \ominus)
240 g

E13 - Stainless steel Ø12 roller plunger

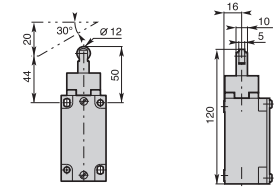

Conformity EN50041
Min. actuating force
Weight

22N (40N \ominus)
245 g

E21 - Stainless steel lateral plain plunger

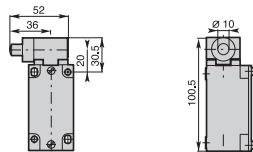

Conformity EN50041
Min. actuating force
Weight

30N (50N \ominus)
260 g

E22 - Stainless steel lateral plunger with Ø12 vertical roller

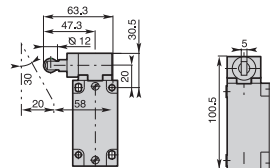

Conformity EN50041
Min. actuating force
Weight

30N (50N \ominus)
265 g

E23 - Stainless steel lateral plunger with Ø12 horizontal roller

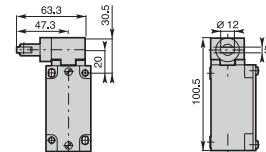

Conformity EN50041
Min. actuating force
Weight

30N (50N \ominus)
265 g

Contact Blocks

| | | | |
|------------------------|-----------|-----------|-----------|
| Z11 (1NO + 1NC) | BM•E21Z11 | BM•E22Z11 | BM•E23Z11 |
| X11 (1NO + 1NC) | BM•E21X11 | BM•E22X11 | BM•E23X11 |
| Y11 (1NO + 1NC) | BM•E21Y11 | BM•E22Y11 | BM•E23Y11 |
| W02 (2NC) | BM•E21W02 | BM•E22W02 | BM•E23W02 |
| W20 (2NO) | BM•E21W20 | BM•E22W20 | BM•E23W20 |
| Z02 (2NC) | BM•E21Z02 | BM•E22Z02 | BM•E23Z02 |
| X12 (1NO + 2NC) | BM•E21X12 | BM•E22X12 | BM•E23X12 |
| X21 (2NO + 1NC) | BM•E21X21 | BM•E22X21 | BM•E23X21 |
| W03 (3NC) | BM•E21W03 | BM•E22W03 | BM•E23W03 |
| W30 (3NO) | BM•E21W30 | BM•E22W30 | BM•E23W30 |

Operation diagrams: page 125 - All dimensions are in mm

Limit Switches **BM_E** series

Metal Casing IP66 - 40 mm. width

Electrical connection:

- BM1:** one cable inlet for PG 13,5 Cable Gland
- BM2:** one cable inlet for 1/2" NPT Cable Gland
- BM5:** one cable inlet for M20 x 1,5 Cable Gland
- BM10:** 5 poles M12 plastic connector
- BM11:** 8 poles M12 plastic connector

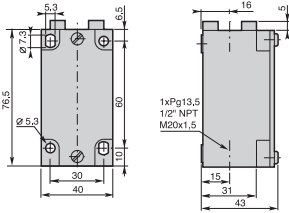

Contact Blocks

| | | | | | |
|------------------------|-----------|-----------|-----------|-----------|-----------|
| Z11 (1NO + 1NC) | BM•E31Z11 | BM•E32Z11 | BM•E33Z11 | BM•E41Z11 | BM•E42Z11 |
| X11 (1NO + 1NC) | BM•E31X11 | BM•E32X11 | BM•E33X11 | BM•E41X11 | BM•E42X11 |
| Y11 (1NO + 1NC) | BM•E31Y11 | BM•E32Y11 | BM•E33Y11 | BM•E41Y11 | BM•E42Y11 |
| W02 (2NC) | BM•E31W02 | BM•E32W02 | BM•E33W02 | BM•E41W02 | BM•E42W02 |
| W20 (2NO) | BM•E31W20 | BM•E32W20 | BM•E33W20 | BM•E41W20 | BM•E42W20 |
| Z02 (2NC) | BM•E31Z02 | BM•E32Z02 | BM•E33Z02 | BM•E41Z02 | BM•E42Z02 |
| X12 (1NO + 2NC) | BM•E31X12 | BM•E32X12 | BM•E33X12 | BM•E41X12 | BM•E42X12 |
| X21 (2NO + 1NC) | BM•E31X21 | BM•E32X21 | BM•E33X21 | BM•E41X21 | BM•E42X21 |
| W03 (3NC) | BM•E31W03 | BM•E32W03 | BM•E33W03 | BM•E41W03 | BM•E42W03 |
| W30 (3NO) | BM•E31W30 | BM•E32W30 | BM•E33W30 | BM•E41W30 | BM•E42W30 |

E3• - One way lever

E31: Ø22 nylon roller E32: Ø22 stainless steel roller

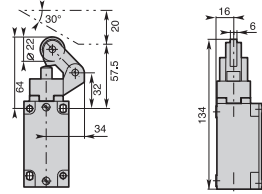

Min. actuating force
Weight

12N (40N ⊖)
280 g

E33 - One way lever Ø22 steel ball bearing

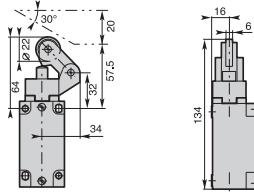

Min. actuating force
Weight

12N (40N ⊖)
280 g

E4• - Ø22 roller lever

E41: Ø22 nylon roller E42: Ø22 stainless steel roller

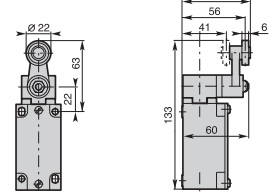

Conformity EN50041

Min. actuating torque
Weight

0,15Nm (0,30Nm ⊖)
300 g

E43 - Ø22 roller lever steel ball bearing

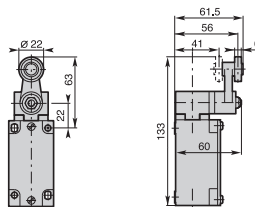

Conformity EN50041

Min. actuating torque
Weight

0,15Nm (0,30Nm ⊖)
300 g

E44 - Ø50 rubber roller lever

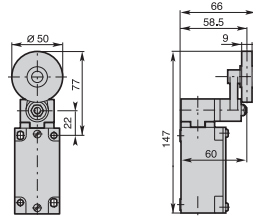

Min. actuating torque
Weight

0,15Nm (0,30Nm ⊖)
315 g

E48 - Lever with nylon roller Ø20

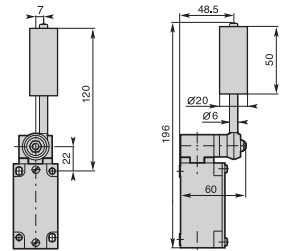

Min. actuating torque
Weight

0,15Nm (0,30Nm ⊖)
340 g

Contact Blocks

| | | | |
|------------------------|-----------|-----------|-----------|
| Z11 (1NO + 1NC) | BM•E43Z11 | BM•E44Z11 | BM•E48Z11 |
| X11 (1NO + 1NC) | BM•E43X11 | BM•E44X11 | BM•E48X11 |
| Y11 (1NO + 1NC) | BM•E43Y11 | BM•E44Y11 | BM•E48Y11 |
| W02 (2NC) | BM•E43W02 | BM•E44W02 | BM•E48W02 |
| W20 (2NO) | BM•E43W20 | BM•E44W20 | BM•E48W20 |
| Z02 (2NC) | BM•E43Z02 | BM•E44Z02 | BM•E48Z02 |
| X12 (1NO + 2NC) | BM•E43X12 | BM•E44X12 | BM•E48X12 |
| X21 (2NO + 1NC) | BM•E43X21 | BM•E44X21 | BM•E48X21 |
| W03 (3NC) | BM•E43W03 | BM•E44W03 | BM•E48W03 |
| W30 (3NO) | BM•E43W30 | BM•E44W30 | BM•E48W30 |

Operation diagrams: page 125 - All dimensions are in mm

Limit Switches **BM_E** series

Metal Casing IP66 - 40 mm. width

Electrical connection:

- BM1:** one cable inlet for PG 13,5 Cable Gland
- BM2:** one cable inlet for 1/2" NPT Cable Gland
- BM5:** one cable inlet for M20 x 1,5 Cable Gland
- BM10:** 5 poles M12 plastic connector
- BM11:** 8 poles M12 plastic connector

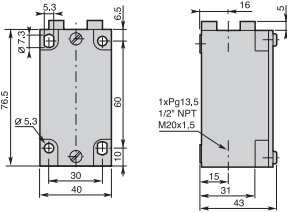

Contact Blocks

| | | | | |
|------------------------|-----------|-----------|-----------|-----------|
| Z11 (1NO + 1NC) | BM•E51Z11 | BM•E52Z11 | BM•E53Z11 | BM•E54Z10 |
| X11 (1NO + 1NC) | BM•E51X11 | BM•E52X11 | BM•E53X11 | BM•E54X11 |
| Y11 (1NO + 1NC) | BM•E51Y11 | BM•E52Y11 | BM•E53Y11 | BM•E54Y11 |
| W02 (2NC) | BM•E51W02 | BM•E52W02 | BM•E53W02 | BM•E54W02 |
| W20 (2NO) | BM•E51W20 | BM•E52W20 | BM•E53W20 | BM•E54W20 |
| Z02 (2NC) | BM•E51Z02 | BM•E52Z02 | BM•E53Z02 | BM•E54Z02 |
| X12 (1NO + 2NC) | BM•E51X12 | BM•E52X12 | BM•E53X12 | BM•E54X12 |
| X21 (2NO + 1NC) | BM•E51X21 | BM•E52X21 | BM•E53X21 | BM•E54X21 |
| W03 (3NC) | BM•E51W03 | BM•E52W03 | BM•E53W03 | BM•E54W03 |
| W30 (3NO) | BM•E51W30 | BM•E52W30 | BM•E53W30 | BM•E54W30 |

E5• - Adjustable Ø22 roller lever

E51: nylon roller E52: stainless steel roller

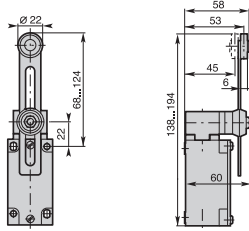

Min. actuating torque **0,15Nm (0,30Nm ⊖)**
Weight **320 g**

E53 - Adjustable Ø22 roller lever with steel ball bearing

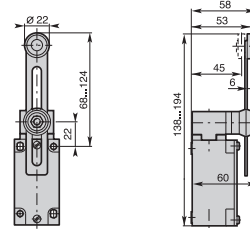

Min. actuating torque **0,15Nm (0,30Nm ⊖)**
Weight **320 g**

E54 - Adjustable Ø50 rubber roller lever

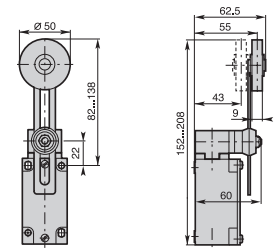

Min. actuating torque **0,15Nm (0,30Nm ⊖)**
Weight **325 g**

E61 - Nylon actuator with stainless steel spring

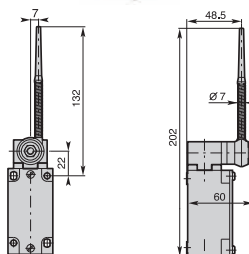

Min. actuating torque **0,15Nm**
Weight **305 g**

E62 - Stainless steel spring actuator

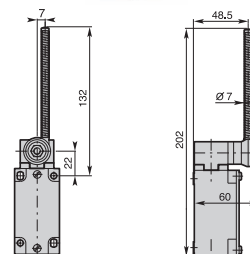

Min. actuating torque **0,15Nm**
Weight **310 g**

E7• - Adjustable Ø3 rod lever

E71: stainless steel rod E73: fiberglass rod

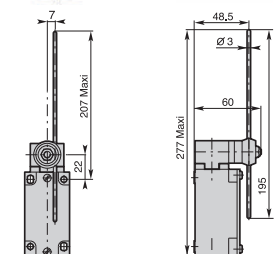

Conformity **EN50041**
Min. actuating torque **0,15Nm (0,30Nm ⊖)**
Weight **305 g**

Contact Blocks

| | | | | |
|------------------------|-----------|-----------|-----------|-----------|
| Z11 (1NO + 1NC) | BM•E61Z11 | BM•E62Z11 | BM•E71Z11 | BM•E73Z11 |
| X11 (1NO + 1NC) | BM•E61X11 | BM•E62X11 | BM•E71X11 | BM•E73X11 |
| Y11 (1NO + 1NC) | BM•E61Y11 | BM•E62Y11 | BM•E71Y11 | BM•E73Y11 |
| W02 (2NC) | BM•E61W02 | BM•E62W02 | BM•E71W02 | BM•E73W02 |
| W20 (2NO) | BM•E61W20 | BM•E62W20 | BM•E71W20 | BM•E73W20 |
| Z02 (2NC) | BM•E61Z02 | BM•E62Z02 | BM•E71Z02 | BM•E73Z02 |
| X12 (1NO + 2NC) | BM•E61X12 | BM•E62X12 | BM•E71X12 | BM•E73X12 |
| X21 (2NO + 1NC) | BM•E61X21 | BM•E62X21 | BM•E71X21 | BM•E73X21 |
| W03 (3NC) | BM•E61W03 | BM•E62W03 | BM•E71W03 | BM•E73W03 |
| W30 (3NO) | BM•E61W30 | BM•E62W30 | BM•E71W30 | BM•E73W30 |

Operation diagrams: page 125 - All dimensions are in mm

Limit Switches **BM_E** series

Metal Casing IP66 - 40 mm. width

Electrical connection:

- BM1:** one cable inlet for PG 13,5 Cable Gland
- BM2:** one cable inlet for 1/2" NPT Cable Gland
- BM5:** one cable inlet for M20 x 1,5 Cable Gland
- BM10:** 5 poles M12 plastic connector
- BM11:** 8 poles M12 plastic connector

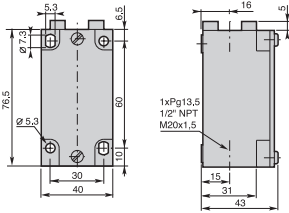

Contact Blocks

| | | | | |
|------------------------|-----------|-----------|-----------|-----------|
| Z11 (1NO + 1NC) | BM•E72Z11 | BM•E74Z11 | BM•E75Z11 | BM•E91Z11 |
| X11 (1NO + 1NC) | BM•E72X11 | BM•E74X11 | BM•E75X11 | BM•E91X11 |
| Y11 (1NO + 1NC) | BM•E72Y11 | BM•E74Y11 | BM•E75Y11 | BM•E91Y11 |
| W02 (2NC) | BM•E72W02 | BM•E74W02 | BM•E75W02 | BM•E91W02 |
| W20 (2NA) | BM•E72W20 | BM•E74W20 | BM•E75W20 | BM•E91W20 |
| Z02 (2NC) | BM•E72Z02 | BM•E74Z02 | BM•E75Z02 | BM•E91Z02 |
| X12 (1NO + 2NC) | BM•E72X12 | BM•E74X12 | BM•E75X12 | BM•E91X12 |
| X21 (2NO + 1NC) | BM•E72X21 | BM•E74X21 | BM•E75X21 | BM•E91X21 |
| W03 (3NC) | BM•E72W03 | BM•E74W03 | BM•E75W03 | BM•E91W03 |
| W30 (3NO) | BM•E72W30 | BM•E74W30 | BM•E75W30 | BM•E91W30 |

E7• - Adjustable rod lever

E72 - Ø6 nylon rod lever E74 - Ø6 fiberglass rod lever

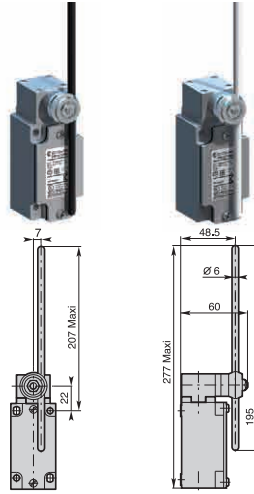

Conformity EN50041

Min. actuating torque 0,15Nm (0,30Nm ⇄)
Weight 300 g

E75 - Adjustable 3x3 square steel rod lever

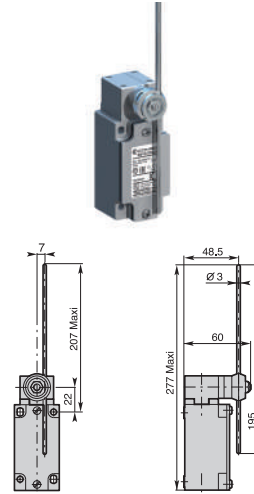

Conformity EN50041

Min. actuating torque 0,15Nm (0,30Nm ⇄)
Weight 305 g

E91 - Stainless steel spring multidirectional actuator

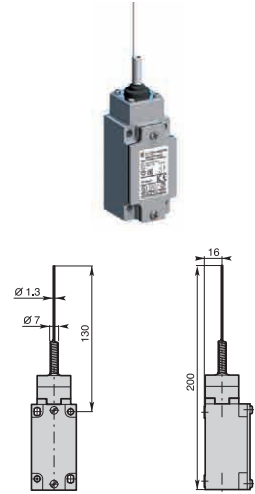

Min. actuating torque 0,18Nm
Weight 230 g

E92 - Multidirectional nylon actuator with stainless steel spring

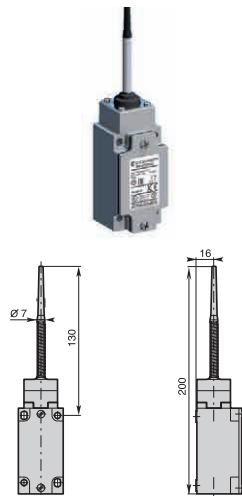

Min. actuating torque 0,18Nm
Weight 230 g

E93 - Stainless steel spring multidirectional actuator

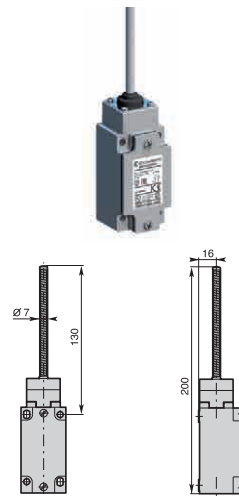

Min. actuating torque 0,18Nm
Weight 235 g

E99 - Pull action with ring

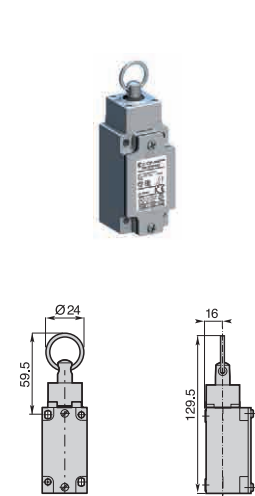

Min. actuating force 25N
Weight 245 g

Contact Blocks

| | | | |
|------------------------|-----------|-----------|------------|
| Z11 (1NO + 1NC) | BM•E92Z11 | BM•E93Z11 | BM•E99Z11A |
| X11 (1NO + 1NC) | BM•E92X11 | BM•E93X11 | BM•E99X11A |
| Y11 (1NO + 1NC) | BM•E92Y11 | BM•E93Y11 | BM•E99Y11A |
| W02 (2NC) | BM•E92W02 | BM•E93W02 | BM•E99W02A |
| W20 (2NO) | BM•E92W20 | BM•E93W20 | BM•E99W20A |
| Z02 (2NC) | BM•E92Z02 | BM•E93Z02 | |
| X12 (1NO + 2NC) | BM•E92X12 | BM•E93X12 | BM•E99X12A |
| X21 (2NO + 1NC) | BM•E92X21 | BM•E93X21 | BM•E99X21A |
| W03 (3NC) | BM•E92W03 | BM•E93W03 | BM•E99W03A |
| W30 (3NO) | BM•E92W30 | BM•E93W30 | BM•E99W30A |

Operation diagrams: page 125 - All dimensions are in mm

Limit Switches **BM_P** series

Metal Casing IP66 - 40 mm. width

Electrical connection:

- BM1:** one cable inlet for PG 13,5 Cable Gland
- BM2:** one cable inlet for 1/2" NPT Cable Gland
- BM5:** one cable inlet for M20 x 1,5 Cable Gland
- BM10:** 5 poles M12 plastic connector
- BM11:** 8 poles M12 plastic connector

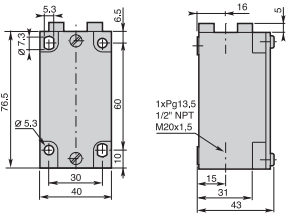

Contact Blocks

| | | | |
|------------------------|-----------|-----------|-----------|
| Z11 (1NO + 1NC) | BM•P11Z11 | BM•P92Z11 | BM•P93Z11 |
| X11 (1NO + 1NC) | BM•P11X11 | BM•P92X11 | BM•P93X11 |
| Y11 (1NO + 1NC) | BM•P11Y11 | BM•P92Y11 | BM•P93Y11 |
| W02 (2NC) | BM•P11W02 | BM•P92W02 | BM•P93W02 |
| W20 (2NO) | BM•P11W20 | BM•P92W20 | BM•P93W20 |
| Z02 (2NC) | BM•P11Z02 | BM•P92Z02 | BM•P93Z02 |
| X12 (1NO + 2NC) | BM•P11X12 | BM•P92X12 | BM•P93X12 |
| X21 (2NO + 1NC) | BM•P11X21 | BM•P92X21 | BM•P93X21 |
| W03 (3NC) | BM•P11W03 | BM•P92W03 | BM•P93W03 |
| W30 (3NO) | BM•P11W30 | BM•P92W30 | BM•P93W30 |

P11 - Plain plunger

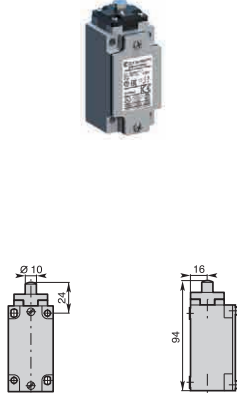

Min. actuating force
Weight

30N (45N ⊖)
220 g

P92 - Multidirectional nylon actuator with stainless steel spring

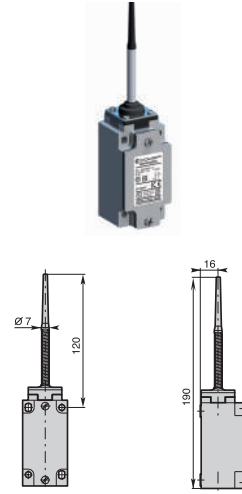

Min. actuating torque
Weight

0,18Nm
210 g

P93 - Stainless steel spring multidirectional actuator



Min. actuating torque
Weight

0,18Nm
215 g

Limit Switches **BM_M** series

Metal Casing IP66 - 40 mm. width

Electrical connection:

- BM1:** one cable inlet for PG 13,5 Cable Gland
- BM2:** one cable inlet for 1/2" NPT Cable Gland
- BM5:** one cable inlet for M20 x 1,5 Cable Gland
- BM10:** 5 poles M12 plastic connector
- BM11:** 8 poles M12 plastic connector

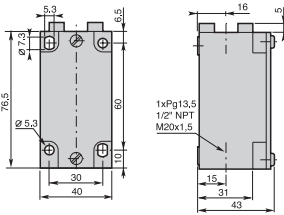

Contact Blocks

| | | | |
|------------------------|-----------|-----------|-----------|
| Z11 (1NO + 1NC) | BM•M13Z11 | BM•M14Z11 | BM•M19Z11 |
| X11 (1NO + 1NC) | BM•M13X11 | BM•M14X11 | BM•M19X11 |
| Y11 (1NO + 1NC) | BM•M13Y11 | BM•M14Y11 | BM•M19Y11 |
| W02 (2NC) | BM•M13W02 | BM•M14W02 | BM•M19W02 |
| W20 (2NO) | BM•M13W20 | BM•M14W20 | BM•M19W20 |
| Z02 (2NC) | BM•M13Z02 | BM•M14Z02 | BM•M19Z02 |
| X12 (1NO + 2NC) | BM•M13X12 | BM•M14X12 | BM•M19X12 |
| X21 (2NO + 1NC) | BM•M13X21 | BM•M14X21 | BM•M19X21 |
| W03 (3NC) | BM•M13W03 | BM•M14W03 | BM•M19W03 |
| W30 (3NO) | BM•M13W30 | BM•M14W30 | BM•M19W30 |

M13 - Steel roller plunger

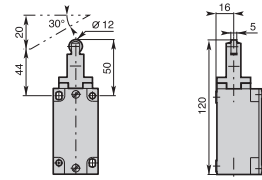

Conformity EN50041
Min. actuating force
Weight

22N (40N \ominus)
265 g

M14 - Plain steel plunger with dust protection cup

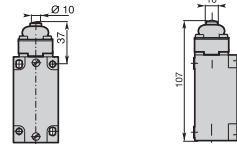

Conformity EN50041
Min. actuating force
Weight

30N (45N \ominus)
255 g

M19 - Steel roller plunger with dust protection cup

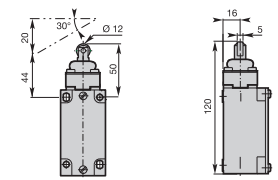

Conformity EN50041
Min. actuating force
Weight

22N (40N \ominus)
265 g

M41 - Ø22 nylon roller lever

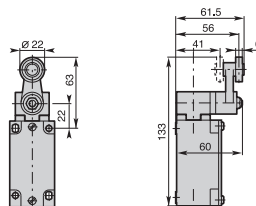

Conformity EN50041
Min. actuating torque
Weight

0,15Nm (0,30Nm \ominus)
300 g

M42 - Ø22 stainless steel roller lever

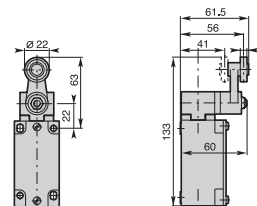

Conformity EN50041
Min. actuating torque
Weight

0,15Nm (0,30Nm \ominus)
300 g

M43 - Ø22 roller lever with steel ball bearing

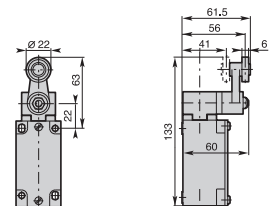

Conformity EN50041
Min. actuating torque
Weight

0,15Nm (0,30Nm \ominus)
300 g

Contact Blocks

| | | | |
|------------------------|-----------|-----------|-----------|
| Z11 (1NO + 1NC) | BM•M41Z11 | BM•M42Z11 | BM•M43Z11 |
| X11 (1NO + 1NC) | BM•M41X11 | BM•M42X11 | BM•M43X11 |
| Y11 (1NO + 1NC) | BM•M41Y11 | BM•M42Y11 | BM•M43Y11 |
| W02 (2NC) | BM•M41W02 | BM•M42W02 | BM•M43W02 |
| W20 (2NO) | BM•M41W20 | BM•M42W20 | BM•M43W20 |
| Z02 (2NC) | BM•M41Z02 | BM•M42Z02 | BM•M43Z02 |
| X12 (1NO + 2NC) | BM•M41X12 | BM•M42X12 | BM•M43X12 |
| X21 (2NO + 1NC) | BM•M41X21 | BM•M42X21 | BM•M43X21 |
| W03 (3NC) | BM•M41W03 | BM•M42W03 | BM•M43W03 |
| W30 (3NO) | BM•M41W30 | BM•M42W30 | BM•M43W30 |

Operation diagrams: page 125 - All dimensions are in mm

Limit Switches **BM_M** series

Metal Casing IP66 - 40 mm. width

Electrical connection:

- BM1:** one cable inlet for PG 13,5 Cable Gland
- BM2:** one cable inlet for 1/2" NPT Cable Gland
- BM5:** one cable inlet for M20 x 1,5 Cable Gland
- BM10:** 5 poles M12 plastic connector
- BM11:** 8 poles M12 plastic connector

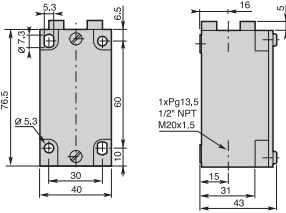

Contact Blocks

| | | | |
|------------------------|-----------|-----------|-----------|
| Z11 (1NO + 1NC) | BM•M44Z11 | BM•M51Z11 | BM•M52Z11 |
| X11 (1NO + 1NC) | BM•M44X11 | BM•M51X11 | BM•M52X11 |
| Y11 (1NO + 1NC) | BM•M44Y11 | BM•M51Y11 | BM•M52Y11 |
| W02 (2NC) | BM•M44W02 | BM•M51W02 | BM•M52W02 |
| W20 (2NO) | BM•M44W20 | BM•M51W20 | BM•M52W20 |
| Z02 (2NC) | BM•M44Z02 | BM•M51Z02 | BM•M52Z02 |
| X12 (1NO + 2NC) | BM•M44X12 | BM•M51X12 | BM•M52X12 |
| X21 (2NO + 1NC) | BM•M44X21 | BM•M51X21 | BM•M52X21 |
| W03 (3NC) | BM•M44W03 | BM•M51W03 | BM•M52W03 |
| W30 (3NO) | BM•M44W30 | BM•M51W30 | BM•M52W30 |

M44 - Ø50 rubber roller lever

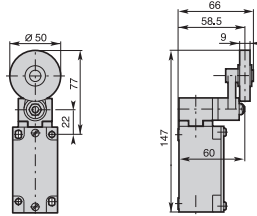

Min. actuating torque 0,15Nm (0,30Nm ⊖)
Weight 310 g

M51 - Adjustable Ø22 nylon roller lever

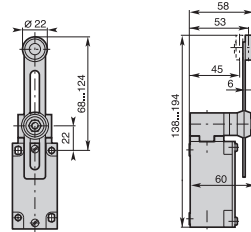

Min. actuating torque 0,15Nm (0,30Nm ⊖)
Weight 320 g

M52 - Adjustable Ø22 stainless steel roller lever

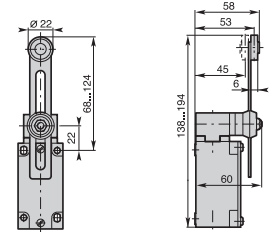

Min. actuating torque 0,15Nm (0,30Nm ⊖)
Weight 320 g

M53 - Adjustable Ø22 roller lever with steel ball bearing

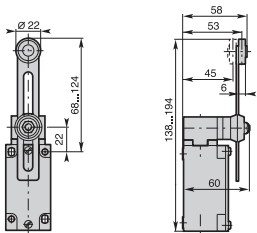

Min. actuating torque 0,15Nm (0,30Nm ⊖)
Weight 320 g

M54 - Adjustable Ø50 rubber roller lever

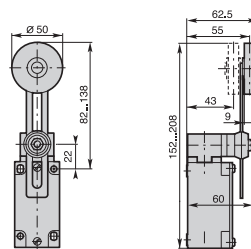

Min. actuating torque 0,15Nm (0,30Nm ⊖)
Weight 325 g

M61 - Nylon actuator with stainless steel spring

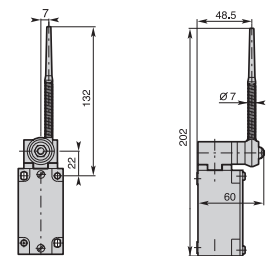

Min. actuating torque 0,15Nm
Weight 325 g

Contact Blocks

| | | | |
|------------------------|-----------|-----------|-----------|
| Z11 (1NO + 1NC) | BM•M53Z11 | BM•M54Z11 | BM•M61Z11 |
| X11 (1NO + 1NC) | BM•M53X11 | BM•M54X11 | BM•M61X11 |
| Y11 (1NO + 1NC) | BM•M53Y11 | BM•M54Y11 | BM•M61Y11 |
| W02 (2NC) | BM•M53W02 | BM•M54W02 | BM•M61W02 |
| W20 (2NO) | BM•M53W20 | BM•M54W20 | BM•M61W20 |
| Z02 (2NC) | BM•M53Z02 | BM•M54Z02 | BM•M61Z02 |
| X12 (1NO + 2NC) | BM•M53X12 | BM•M54X12 | BM•M61X12 |
| X21 (2NO + 1NC) | BM•M53X21 | BM•M54X21 | BM•M61X21 |
| W03 (3NC) | BM•M53W03 | BM•M54W03 | BM•M61W03 |
| W30 (3NO) | BM•M53W30 | BM•M54W30 | BM•M61W30 |

Operation diagrams: page 125 - All dimensions are in mm

Limit Switches **BM_M** series

Metal Casing IP66 - 40 mm. width

Electrical connection:

- BM1:** one cable inlet for PG 13,5 Cable Gland
- BM2:** one cable inlet for 1/2" NPT Cable Gland
- BM5:** one cable inlet for M20 x 1,5 Cable Gland
- BM10:** 5 poles M12 plastic connector
- BM11:** 8 poles M12 plastic connector

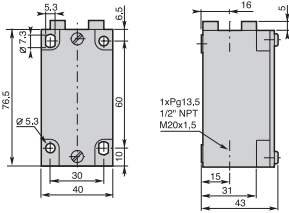

Contact Blocks

| | | | |
|------------------------|-----------|-----------|-----------|
| Z11 (1NO + 1NC) | BM•M62Z11 | BM•M71Z11 | BM•M72Z11 |
| X11 (1NO + 1NC) | BM•M62X11 | BM•M71X11 | BM•M72X11 |
| Y11 (1NO + 1NC) | BM•M62Y11 | BM•M71Y11 | BM•M72Y11 |
| W02 (2NC) | BM•M62W02 | BM•M71W02 | BM•M72W02 |
| W20 (2NO) | BM•M62W20 | BM•M71W20 | BM•M72W20 |
| Z02 (2NC) | BM•M62Z02 | BM•M71Z02 | BM•M72Z02 |
| X12 (1NO + 2NC) | BM•M62X12 | BM•M71X12 | BM•M72X12 |
| X21 (2NO + 1NC) | BM•M62X21 | BM•M71X21 | BM•M72X21 |
| W03 (3NC) | BM•M62W03 | BM•M71W03 | BM•M72W03 |
| W30 (3NO) | BM•M62W30 | BM•M71W30 | BM•M72W30 |

M62 - Stainless steel spring actuator

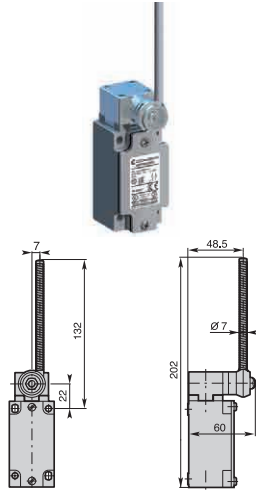

Min. actuating torque
Weight

0,15Nm
325 g

M71 - Adjustable Ø3 stainless steel rod lever

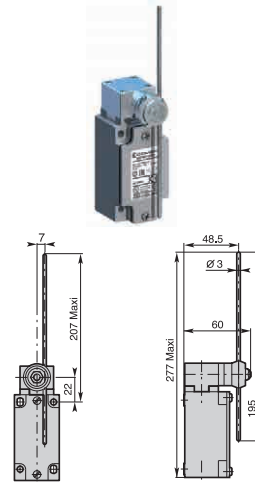

Conformity EN50041

Min. actuating torque
Weight

0,15Nm (0,30Nm ⇄)
325 g

M72 - Adjustable Ø6 nylon rod lever

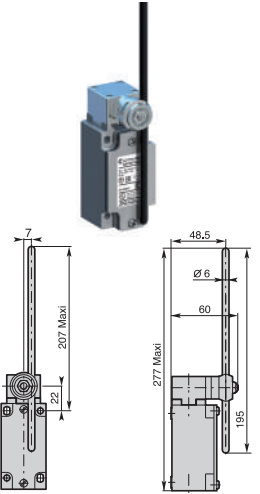

Conformity EN50041

Min. actuating torque
Weight

0,15Nm (0,30Nm ⇄)
325 g

M73 - Adjustable Ø3 fiberglass rod lever

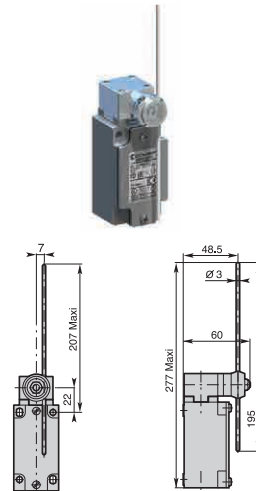

Conformity EN50041

Min. actuating torque
Weight

0,15Nm (0,30Nm ⇄)
325 g

M74 - Adjustable Ø6 fiberglass rod lever

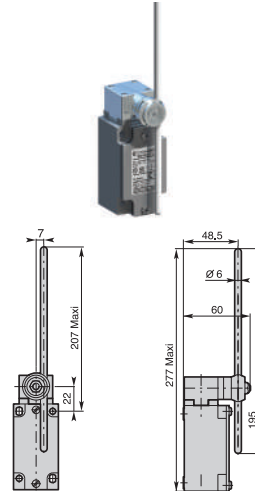

Conformity EN50041

Min. actuating torque
Weight

0,15Nm (0,30Nm ⇄)
325 g

M75 - Adjustable 3x3 square steel rod lever

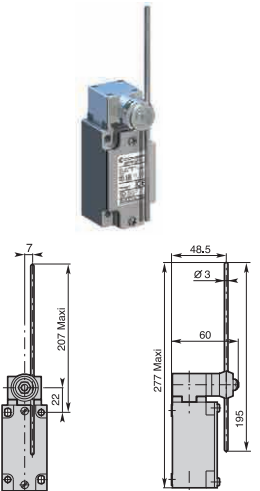

Conformity EN50041

Min. actuating torque
Weight

0,15Nm (0,30Nm ⇄)
325 g

Contact Blocks

| | | | |
|------------------------|-----------|-----------|-----------|
| Z11 (1NO + 1NC) | BM•M73Z11 | BM•M74Z11 | BM•M75Z11 |
| X11 (1NO + 1NC) | BM•M73X11 | BM•M74X11 | BM•M75X11 |
| Y11 (1NO + 1NC) | BM•M73Y11 | BM•M74Y11 | BM•M75Y11 |
| W02 (2NC) | BM•M73W02 | BM•M74W02 | BM•M75W02 |
| W20 (2NO) | BM•M73W20 | BM•M74W20 | BM•M75W20 |
| Z02 (2NC) | BM•M73Z02 | BM•M74Z02 | BM•M75Z02 |
| X12 (1NO + 2NC) | BM•M73X12 | BM•M74X12 | BM•M75X12 |
| X21 (2NO + 1NC) | BM•M73X21 | BM•M74X21 | BM•M75X21 |
| W03 (3NC) | BM•M73W03 | BM•M74W03 | BM•M75W03 |
| W30 (3NO) | BM•M73W30 | BM•M74W30 | BM•M75W30 |

Operation diagrams: page 125 - All dimensions are in mm